

ハニカムスペーサー I 型 SU 管 /SGP 管

9100

製品用途 高さ調整	材質 エラストマー	温度域 -60℃～+98℃
--------------	--------------	------------------

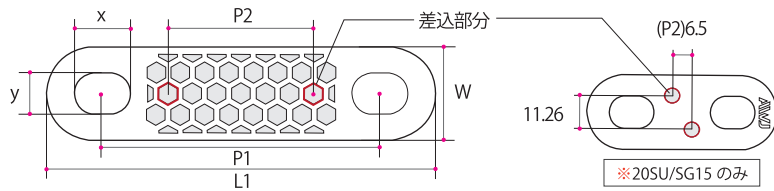
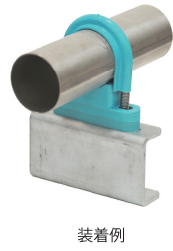
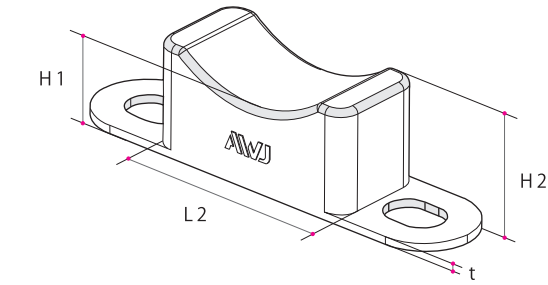

AWJ ブルー 品番	呼称 SU/SGP	適合 管径	P1	P2	L1	L2	W	H1	H2	x	y	t	出荷単位 箱	ブラック 品番	呼称 SU/SGP
HSSG10-0015	SG15	21.7	34	※	64	17	25	20	22.5	15	11	2	250 個	BHSSG10-0015	SG15
HSSG10-0020	SG20	27.2	40	13	70	23	25	20	23	15	11	2	200 個	BHSSG10-0020	SG20
HSSU10-0020	20SU	22.22	34	※	64	17	25	20	22.5	15	11	2	250 個	BHSSU10-0020	20SU
HSSU10-0025	25SU	28.58	40	13	70	23	25	20	23	15	11	2	200 個	BHSSU10-0025	25SU
HSSU10-0030	30SU/SG25	34	46	13	76	29	25	20	24	15	11	2	180 個	BHSSU10-0030	30SU/SG25
HSSU10-0040	40SU/SG32	42.7	56	26	86	38	25	20	24.5	15	11	2	150 個	BHSSU10-0040	40SU/SG32
HSSU10-0050	50SU/SG40	48.6	62	26	92	42	25	20	26.5	15	11	2	130 個	BHSSU10-0050	50SU/SG40
HSSU10-0060	60SU/SG50	60.5	74	39	104	54	25	20	27	15	11	2	100 個	BHSSU10-0060	60SU/SG50
HSSU10-0075	75SU/SG65	76.3	88	52	118	68	25	20	28	15	11	2	80 個	BHSSU10-0075	75SU/SG65
HSSU10-0080	80SU/SG80	89.1	101	65	131	81	25	20	29	15	11	2	60 個	BHSSU10-0080	80SU/SG80
HSSU10-0100	100SU/SG100	114.3	126	91	156	106	25	20	30	15	11	2	50 個	BHSSU10-0100	100SU/SG100

※30SU/SG25 以降 SU・SGP 管は同じ品番になります。

ハニカムスペーサー II 型 SU 管 /SGP 管

9101

製品用途 高さ調整	材質 エラストマー	温度域 -60℃～+98℃
--------------	--------------	------------------

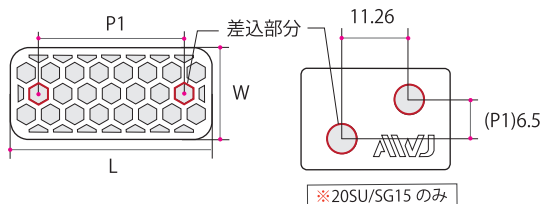
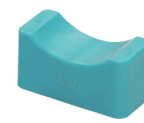
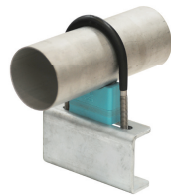
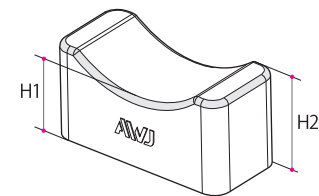

AWJ ブルー 品番	呼称 SU/SGP	適合 管径	P1	L	W	H1	H2	出荷単位 箱	ブラック 品番	呼称 SU/SGP
HSSG20-0015	SG15	21.7	※	17	25	20	22.5	250 個	BHSSG20-0015	SG15
HSSG20-0020	SG20	27.2	13	23	25	20	23	200 個	BHSSG20-0020	SG20
HSSU20-0020	20SU	22.22	※	17	25	20	22.5	250 個	BHSSU20-0020	20SU
HSSU20-0025	25SU	28.58	13	23	25	20	23	200 個	BHSSU20-0025	25SU
HSSU20-0030	30SU/SG25	34	13	29	25	20	24	180 個	BHSSU20-0030	30SU/SG25
HSSU20-0040	40SU/SG32	42.7	26	38	25	20	24.5	150 個	BHSSU20-0040	40SU/SG32
HSSU20-0050	50SU/SG40	48.6	26	42	25	20	26.5	130 個	BHSSU20-0050	50SU/SG40
HSSU20-0060	60SU/SG50	60.5	39	54	25	20	27	100 個	BHSSU20-0060	60SU/SG50
HSSU20-0075	75SU/SG65	76.3	52	68	25	20	28	80 個	BHSSU20-0075	75SU/SG65
HSSU20-0080	80SU/SG80	89.1	65	81	25	20	29	60 個	BHSSU20-0080	80SU/SG80
HSSU20-0100	100SU/SG100	114.3	91	106	25	20	30	50 個	BHSSU20-0100	100SU/SG100

※30SU/SG25 以降 SU・SGP 管は同じ品番になります。

製品用途	材質	温度域
高さ調整	エラストマー	-60℃～+98℃

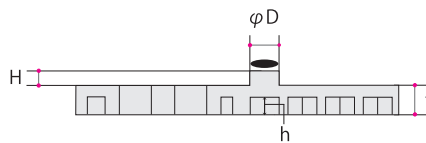
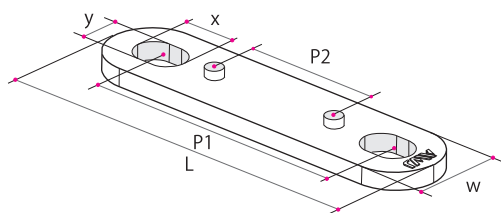

断面図 [Cross section]

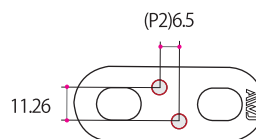

※20SU/SG15のみ



3mm



5mm



10mm



【図面ダウンロード】



【YouTube】

3mm シムプレート I 型用 (SU/SGP 管用)

AWJ ブルー品番	呼称 SU/SGP	P1	P2	L	W	D	H	h	x	y	t	出荷単位	箱	ブラック品番	呼称 SU/SGP
HSSG10-01503	SG15	34	※	64	25	5	2.5	2.6	15	11	3	100	個	BHSSG10-01503	SG15
HSSG10-02003	SG20	40	13	70	25	5	2.5	2.6	15	11	3	100	個	BHSSG10-02003	SG20
HSSU10-02003	20SU	34	※	64	25	5	2.5	2.6	15	11	3	100	個	BHSSU10-02003	20SU
HSSU10-02503	25SU	40	13	70	25	5	2.5	2.6	15	11	3	100	個	BHSSU10-02503	25SU
HSSU10-03003	30SU/SG25	46	13	76	25	5	2.5	2.6	15	11	3	100	個	BHSSU10-03003	30SU/SG25
HSSU10-04003	40SU/SG32	56	26	86	25	5	2.5	2.6	15	11	3	100	個	BHSSU10-04003	40SU/SG32
HSSU10-05003	50SU/SG40	62	26	92	25	5	2.5	2.6	15	11	3	100	個	BHSSU10-05003	50SU/SG40
HSSU10-06003	60SU/SG50	74	39	104	25	5	2.5	2.6	15	11	3	100	個	BHSSU10-06003	60SU/SG50
HSSU10-07503	75SU/SG65	88	52	118	25	5	2.5	2.6	15	11	3	100	個	BHSSU10-07503	75SU/SG65
HSSU10-08003	80SU/SG80	101	65	131	25	5	2.5	2.6	15	11	3	100	個	BHSSU10-08003	80SU/SG80
HSSU10-10003	100SU/SG100	126	91	156	25	5	2.5	2.6	15	11	3	100	個	BHSSU10-10003	100SU/SG100

5mm シムプレート I 型用 (SU/SGP 管用)

AWJ ブルー品番	呼称 SU/SGP	P1	P2	L	W	D	H	h	x	y	t	出荷単位	箱	ブラック品番	呼称 SU/SGP
HSSG10-01505	SG15	34	※	64	25	5	2.5	3	15	11	5	100	個	BHSSG10-01505	SG15
HSSG10-02005	SG20	40	13	70	25	5	2.5	3	15	11	5	100	個	BHSSG10-02005	SG20
HSSU10-02005	20SU	34	※	64	25	5	2.5	3	15	11	5	100	個	BHSSU10-02005	20SU
HSSU10-02505	25SU	40	13	70	25	5	2.5	3	15	11	5	100	個	BHSSU10-02505	25SU
HSSU10-03005	30SU/SG25	46	13	76	25	5	2.5	3	15	11	5	100	個	BHSSU10-03005	30SU/SG25
HSSU10-04005	40SU/SG32	56	26	86	25	5	2.5	3	15	11	5	100	個	BHSSU10-04005	40SU/SG32
HSSU10-05005	50SU/SG40	62	26	92	25	5	2.5	3	15	11	5	100	個	BHSSU10-05005	50SU/SG40
HSSU10-06005	60SU/SG50	74	39	104	25	5	2.5	3	15	11	5	100	個	BHSSU10-06005	60SU/SG50
HSSU10-07505	75SU/SG65	88	52	118	25	5	2.5	3	15	11	5	100	個	BHSSU10-07505	75SU/SG65
HSSU10-08005	80SU/SG80	101	65	131	25	5	2.5	3	15	11	5	100	個	BHSSU10-08005	80SU/SG80
HSSU10-10005	100SU/SG100	126	91	156	25	5	2.5	3	15	11	5	100	個	BHSSU10-10005	100SU/SG100

10mm シムプレート I 型用 (SU/SGP 管用)

AWJ ブルー品番	呼称 SU/SGP	P1	P2	L	W	D	H	h	x	y	t	出荷単位	箱	ブラック品番	呼称 SU/SGP
HSSG10-01510	SG15	34	※	64	25	5	2.5	8	15	11	10	50	個	BHSSG10-01510	SG15
HSSG10-02010	SG20	40	13	70	25	5	2.5	8	15	11	10	50	個	BHSSG10-02010	SG20
HSSU10-02010	20SU	34	※	64	25	5	2.5	8	15	11	10	50	個	BHSSU10-02010	20SU
HSSU10-02510	25SU	40	13	70	25	5	2.5	8	15	11	10	50	個	BHSSU10-02510	25SU
HSSU10-03010	30SU/SG25	46	13	76	25	5	2.5	8	15	11	10	50	個	BHSSU10-03010	30SU/SG25
HSSU10-04010	40SU/SG32	56	26	86	25	5	2.5	8	15	11	10	50	個	BHSSU10-04010	40SU/SG32
HSSU10-05010	50SU/SG40	62	26	92	25	5	2.5	8	15	11	10	50	個	BHSSU10-05010	50SU/SG40
HSSU10-06010	60SU/SG50	74	39	104	25	5	2.5	8	15	11	10	50	個	BHSSU10-06010	60SU/SG50
HSSU10-07510	75SU/SG65	88	52	118	25	5	2.5	8	15	11	10	50	個	BHSSU10-07510	75SU/SG65
HSSU10-08010	80SU/SG80	101	65	131	25	5	2.5	8	15	11	10	50	個	BHSSU10-08010	80SU/SG80
HSSU10-10010	100SU/SG100	126	91	156	25	5	2.5	8	15	11	10	50	個	BHSSU10-10010	100SU/SG100

※30SU/SG25 以降 SU・SGP 管は同じ品番になります。

製品用途	材質	温度域
高さ調整	エラストマー	-60℃～+98℃

※30SU/SG25 以降 SU・SGP 管は同じ品番になります。
 ※ハニカムスペーサー I 型・フラット U ボルト足長の図面は各ページをご覧ください



[+30 + I 型 (30mm)]

AWJ ブルー



[+50 + I 型 (50mm)]

屋外用ブラック



[YouTube]

ユニクロ		呼称	ステンレス		ドブメッキ		ステンレス屋外用	
[+30 + I 型] 品番	[+50 + I 型] 品番	SU/SGP	[+30 + I 型] 品番	[+50 + I 型] 品番	[+30 + I 型] 品番	[+50 + I 型] 品番	[+30 + I 型] 品番	[+50 + I 型] 品番
HSG10349-0153	HSG10349-0155	SG15	HSG10350-0153	HSG10350-0155	HSG10359-0153	HSG10359-0155	HSG10354-0153	HSG10354-0155
HSG10349-0203	HSG10349-0205	SG20	HSG10350-0203	HSG10350-0205	HSG10359-0203	HSG10359-0205	HSG10354-0203	HSG10354-0205
HSU10349-0203	HSU10349-0205	20SU	HSU10350-0203	HSU10350-0205	HSU10359-0203	HSU10359-0205	HSU10354-0203	HSU10354-0205
HSU10349-0253	HSU10349-0255	25SU	HSU10350-0253	HSU10350-0255	HSU10359-0253	HSU10359-0255	HSU10354-0253	HSU10354-0255
HSU10349-0303	HSU10349-0305	30SU/SG25	HSU10350-0303	HSU10350-0305	HSU10359-0303	HSU10359-0305	HSU10354-0303	HSU10354-0305
HSU10349-0403	HSU10349-0405	40SU/SG32	HSU10350-0403	HSU10350-0405	HSU10359-0403	HSU10359-0405	HSU10354-0403	HSU10354-0405
HSU10349-0503	HSU10349-0505	50SU/SG40	HSU10350-0503	HSU10350-0505	HSU10359-0503	HSU10359-0505	HSU10354-0503	HSU10354-0505
HSU10349-0603	HSU10349-0605	60SU/SG50	HSU10350-0603	HSU10350-0605	HSU10359-0603	HSU10359-0605	HSU10354-0603	HSU10354-0605
HSU10349-0753	HSU10349-0755	75SU/SG65	HSU10350-0753	HSU10350-0755	HSU10359-0753	HSU10359-0755	HSU10354-0753	HSU10354-0755
HSU10349-0803	HSU10349-0805	80SU/SG80	HSU10350-0803	HSU10350-0805	HSU10359-0803	HSU10359-0805	HSU10354-0803	HSU10354-0805
HSU10349-1003	HSU10349-1005	100SU/SG100	HSU10350-1003	HSU10350-1005	HSU10359-1003	HSU10359-1005	HSU10354-1003	HSU10354-1005

製品用途	材質	温度域
高さ調整	エラストマー	-60℃～+98℃

※30SU/SG25 以降 SU・SGP 管は同じ品番になります。
 ※ハニカムスペーサー II 型・フラット U ボルト足長の図面は各ページをご覧ください

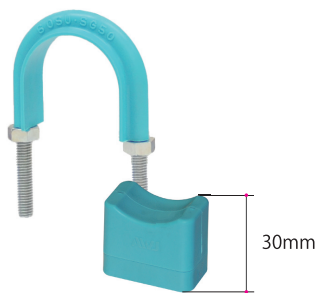

[+30 + II 型 (30mm)]

AWJ ブルー



[+50 + II 型 (50mm)]

屋外用ブラック



[YouTube]

ユニクロ		呼称	ステンレス		ドブメッキ		ステンレス屋外用	
[+30 + I 型] 品番	[+50 + I 型] 品番	SU/SGP	[+30 + I 型] 品番	[+50 + I 型] 品番	[+30 + I 型] 品番	[+50 + I 型] 品番	[+30 + I 型] 品番	[+50 + I 型] 品番
HSG20349-0153	HSG20349-0155	SG15	HSG20350-0153	HSG20350-0155	HSG20359-0153	HSG20359-0155	HSG20354-0153	HSG20354-0155
HSG20349-0203	HSG20349-0205	SG20	HSG20350-0203	HSG20350-0205	HSG20359-0203	HSG20359-0205	HSG20354-0203	HSG20354-0205
HSU20349-0203	HSU20349-0205	20SU	HSU20350-0203	HSU20350-0205	HSU20359-0203	HSU20359-0205	HSU20354-0203	HSU20354-0205
HSU20349-0253	HSU20349-0255	25SU	HSU20350-0253	HSU20350-0255	HSU20359-0253	HSU20359-0255	HSU20354-0253	HSU20354-0255
HSU20349-0303	HSU20349-0305	30SU/SG25	HSU20350-0303	HSU20350-0305	HSU20359-0303	HSU20359-0305	HSU20354-0303	HSU20354-0305
HSU20349-0403	HSU20349-0405	40SU/SG32	HSU20350-0403	HSU20350-0405	HSU20359-0403	HSU20359-0405	HSU20354-0403	HSU20354-0405
HSU20349-0503	HSU20349-0505	50SU/SG40	HSU20350-0503	HSU20350-0505	HSU20359-0503	HSU20359-0505	HSU20354-0503	HSU20354-0505
HSU20349-0603	HSU20349-0605	60SU/SG50	HSU20350-0603	HSU20350-0605	HSU20359-0603	HSU20359-0605	HSU20354-0603	HSU20354-0605
HSU20349-0753	HSU20349-0755	75SU/SG65	HSU20350-0753	HSU20350-0755	HSU20359-0753	HSU20359-0755	HSU20354-0753	HSU20354-0755
HSU20349-0803	HSU20349-0805	80SU/SG80	HSU20350-0803	HSU20350-0805	HSU20359-0803	HSU20359-0805	HSU20354-0803	HSU20354-0805
HSU20349-1003	HSU20349-1005	100SU/SG100	HSU20350-1003	HSU20350-1005	HSU20359-1003	HSU20359-1005	HSU20354-1003	HSU20354-1005

ハニカムスペーサー I 型+シムプレート SU 管 /SGP 管

9106

製品用途	材質	温度域
高さ調整	エラストマー	-60℃～+98℃

※30SU/SG25 以降 SU・SGP 管は同じ品番になります。
 ※図面は各ページをご覧ください。

【30mm の例】



ハニカムスペーサー I 型 20mm

シムプレート 10mm

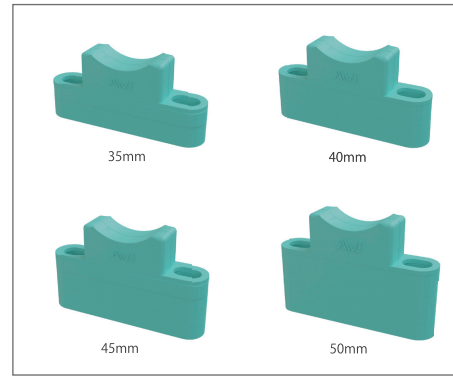

【YouTube】

呼称 SU/SGP	AWJ ブルー 30mm 品番	35mm 品番	40mm 品番	45mm 品番	50mm 品番	ブラック 30mm 品番	35mm 品番	40mm 品番	45mm 品番	50mm 品番
SG15	HSSG10-01530	-01535	-01540	-01545	-01550	BHSSG10-01530	-01535	-01540	-01545	-01550
SG20	HSSG10-02030	-02035	-02040	-02045	-02050	BHSSG10-02030	-02035	-02040	-02045	-02050
20SU	HSSU10-02030	-02035	-02040	-02045	-02050	BHSSU10-02030	-02035	-02040	-02045	-02050
25SU	HSSU10-02530	-02535	-02540	-02545	-02550	BHSSU10-02530	-02535	-02540	-02545	-02550
30SU/SG25	HSSU10-03030	-03035	-03040	-03045	-03050	BHSSU10-03030	-03035	-03040	-03045	-03050
40SU/SG32	HSSU10-04030	-04035	-04040	-04045	-04050	BHSSU10-04030	-04035	-04040	-04045	-04050
50SU/SG40	HSSU10-05030	-05035	-05040	-05045	-05050	BHSSU10-05030	-05035	-05040	-05045	-05050
60SU/SG50	HSSU10-06030	-06035	-06040	-06045	-06050	BHSSU10-06030	-06035	-06040	-06045	-06050
75SU/SG65	HSSU10-07530	-07535	-07540	-07545	-07550	BHSSU10-07530	-07535	-07540	-07545	-07550
80SU/SG80	HSSU10-08030	-08035	-08040	-08045	-08050	BHSSU10-08030	-08035	-08040	-08045	-08050
100SU/SG100	HSSU10-10030	-10035	-10040	-10045	-10050	BHSSU10-10030	-10035	-10040	-10045	-10050

ハニカムスペーサー II 型+シム SU 管 /SGP 管

9107

製品用途	材質	温度域
高さ調整	エラストマー	-60℃～+98℃

※30SU/SG25 以降 SU・SGP 管は同じ品番になります。
 ※図面は各ページをご覧ください。

【35mm の例】

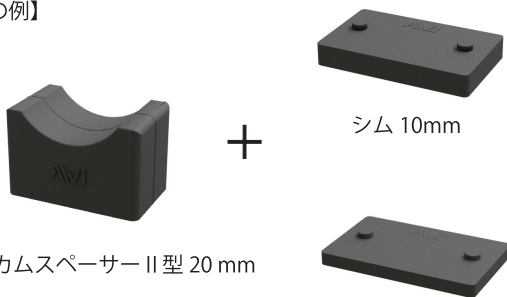

ハニカムスペーサー II 型 20mm

シム 5mm

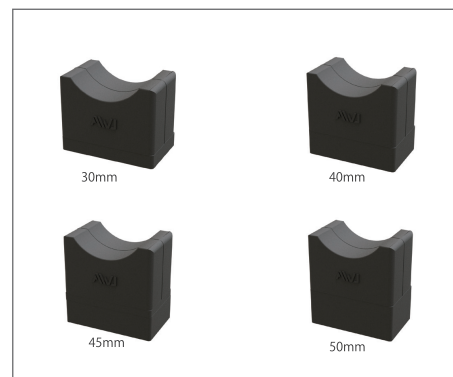

【YouTube】

呼称 SU/SGP	AWJ ブルー 30mm 品番	35mm 品番	40mm 品番	45mm 品番	50mm 品番	ブラック 30mm 品番	35mm 品番	40mm 品番	45mm 品番	50mm 品番
SG15	HSSG20-01530	-01535	-01540	-01545	-01550	BHSSG20-01530	-01535	-01540	-01545	-01550
SG20	HSSG20-02030	-02035	-02040	-02045	-02050	BHSSG20-02030	-02035	-02040	-02045	-02050
20SU	HSSU20-02030	-02035	-02040	-02045	-02050	BHSSU20-02030	-02035	-02040	-02045	-02050
25SU	HSSU20-02530	-02535	-02540	-02545	-02550	BHSSU20-02530	-02535	-02540	-02545	-02550
30SU/SG25	HSSU20-03030	-03035	-03040	-03045	-03050	BHSSU20-03030	-03035	-03040	-03045	-03050
40SU/SG32	HSSU20-04030	-04035	-04040	-04045	-04050	BHSSU20-04030	-04035	-04040	-04045	-04050
50SU/SG40	HSSU20-05030	-05035	-05040	-05045	-05050	BHSSU20-05030	-05035	-05040	-05045	-05050
60SU/SG50	HSSU20-06030	-06035	-06040	-06045	-06050	BHSSU20-06030	-06035	-06040	-06045	-06050
75SU/SG65	HSSU20-07530	-07535	-07540	-07545	-07550	BHSSU20-07530	-07535	-07540	-07545	-07550
80SU/SG80	HSSU20-08030	-08035	-08040	-08045	-08050	BHSSU20-08030	-08035	-08040	-08045	-08050
100SU/SG100	HSSU20-10030	-10035	-10040	-10045	-10050	BHSSU20-10030	-10035	-10040	-10045	-10050